

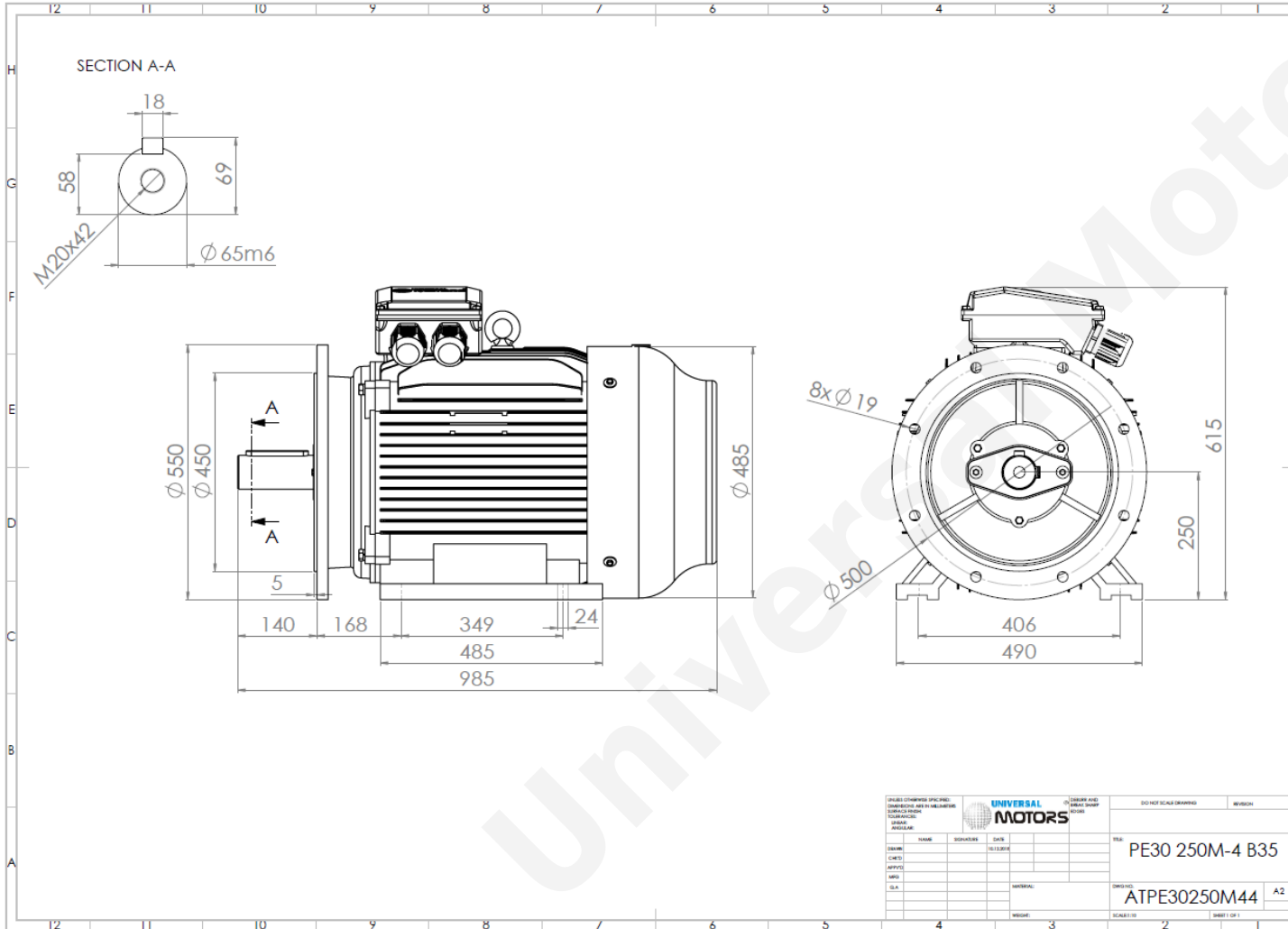

TECHNICAL DATA

Three Phase Electric Motors - Cast Iron Frame
PE30 250 M 6 IE3
37 kW / 50 Cv
990 RPM



Motor type:	PE30 250 M 6 IE3
Output:	37 kW / 50 Cv
Speed (min ⁻¹):	990 RPM
Frequency:	50 Hz
Voltage:	400 V
Current:	68.1 A
Power factor (Cos ϕ):	0.84
Poles:	6
Insulation class:	F
Temperature rise Class:	B
Efficiency 50%:	92.7 %
Efficiency 75%:	93.5 %
Efficiency 100%:	93.4 %
Torque:	357 N.m
Tstarting/Tnominal:	2.0
Istarting/Inominal:	7.1
Tmaximum/Tnominal:	2.1
Noise:	67 Db(A)
Weight:	416 Kg
Bearing DE:	6314 C3
Bearing NDE:	6314 C3

Regime - S1

Altitude - 1000m

Environment Temperature - 40°C

CONTACTS:

UNIVERSAL MOTORS Tel: +351 252 299 080
Rua de São Brás, 745 Fax: +351 252 299 089
4480-782 VILA DO CONDE Mail: geral@universalmotors.pt

* References applied only in the UK